

VFLW4500

CẦU NÂNG 4 TRỤ CHỨC NĂNG KIỂM TRA GÓC LÁI
Four Post Vehicle Lift For Wheel Alignment

VFLW4500

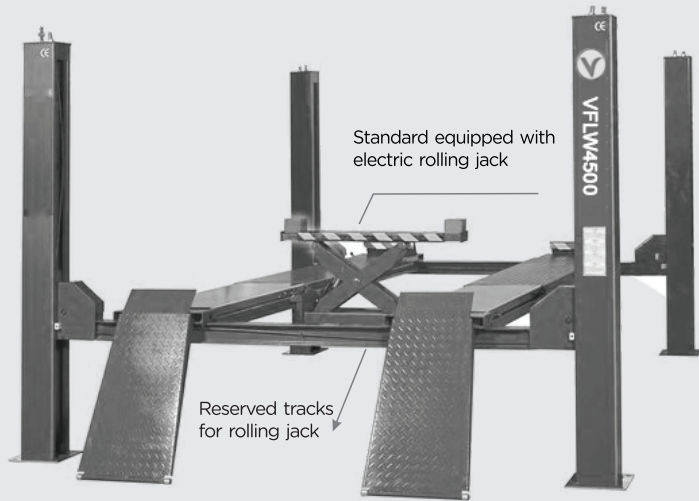

Single Manual Lock Release



For wheel alignment



Optional Pneumatic Lock Release

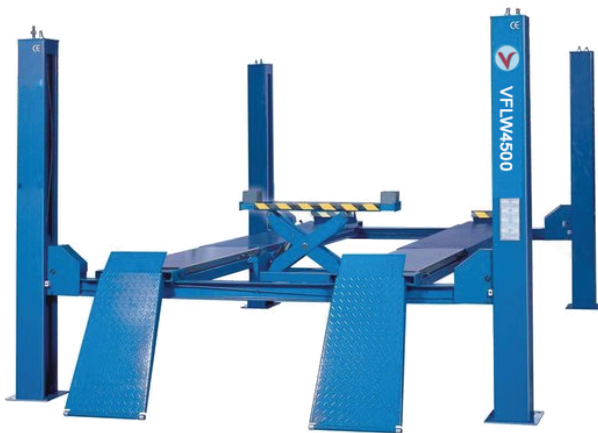

Màu sắc có thể tùy chọn theo yêu cầu

Rolling jack (OPTIONAL)

2T/3T Convenient for clients' self-installation



Manual Control



Pneumatic Control

OPTIONAL



Position-adjustable turntable



Drive-by-wire button



Power unit cover + Cable carrier

SAFETY FEATURES

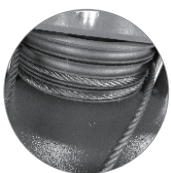

Big Pulley for steel rope



Height limit switch

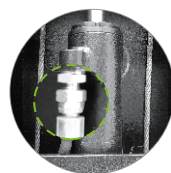

Safety valve for anti-explosion of hydraulic system

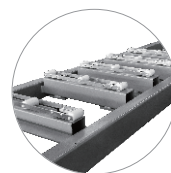

Abrasion resistant slip plates for 4 wheel alignment

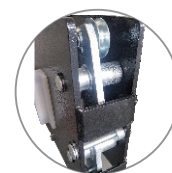

Equipped with main insurance and rope break insurance on each column

DIMENSION

VFLW4500

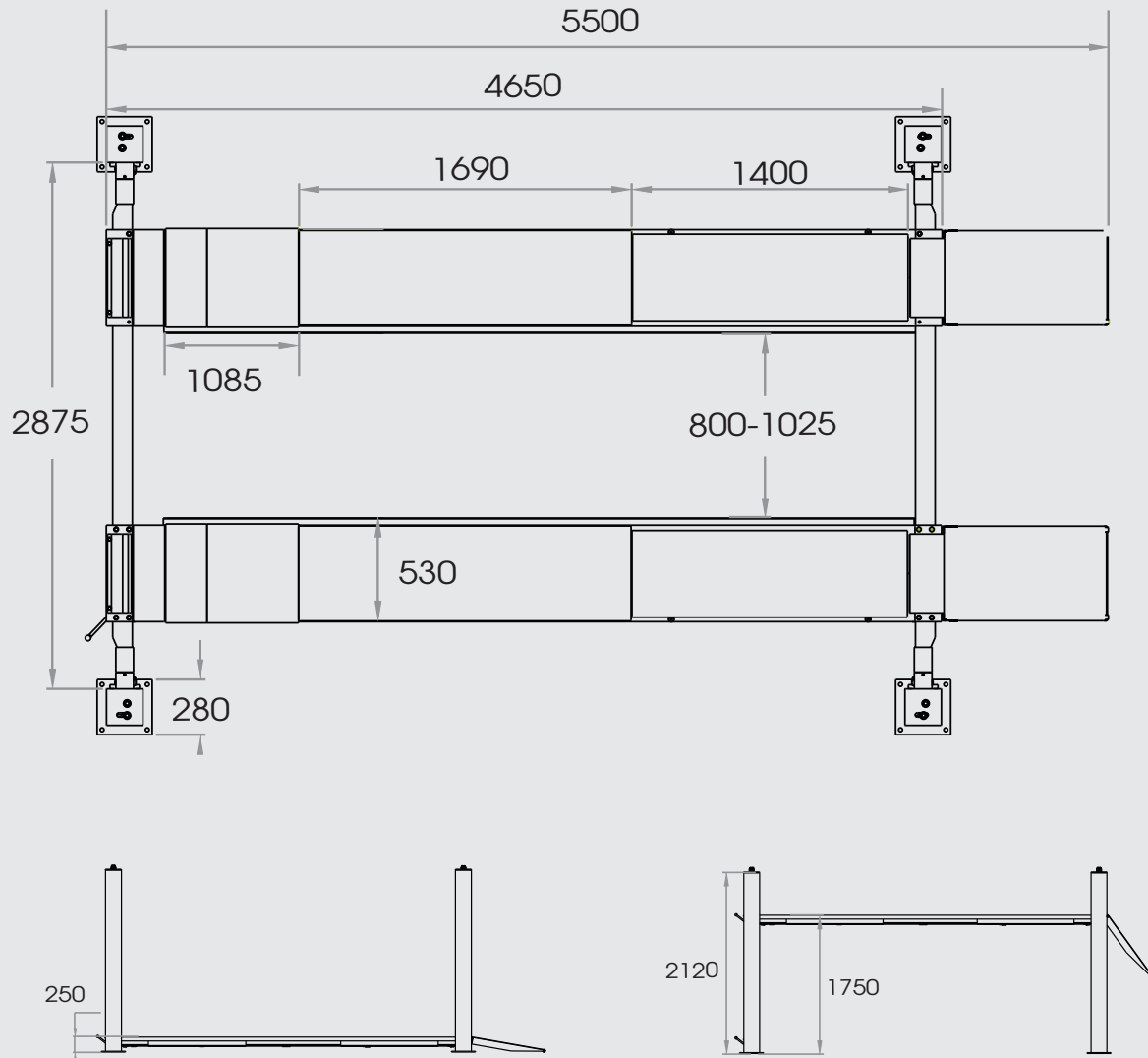

TECHNICAL DATA

Model	VFLW4500
Công suất nâng / Capacity	4.5 Ton
Chiều cao nâng / Lifting Height	1750mm
Chiều cao min. / Min. Height	250mm
Chiều dài bàn nâng / Platform length	4650mm
Nguồn điện / Power supply	220V 1PH 50Hz 2.2KW 380V 3PH 50Hz 2.2KW
Màu sắc	Tùy chọn theo yêu cầu